



TABLE OF CONTENTS

1. INTRODUCTION	2
1.1 General Guidance	2
1.2 Accessing the Installer's Menu.....	2
2. SETTING A NEW INSTALLER CODE	3
3. ENROLLING WIRELESS DEVICES AND KEYFOBS ..	3
3.1 General Guidance	3
3.2 Wireless Devices	3
3.3 Keyfob Transmitters	3
3.4 Deleting Device and Keyfob IDs	4
4. DEFINING ZONE TYPES	5
4.1 Preliminary Guidance	5
4.2 Zone Definition Procedure	5
5. DEFINING CONTROL PANEL PARAMETERS	7
5.1 Preliminary Guidance	7
5.2 Entry Delays	8
5.3 Exit Delay	8
5.4 Bell Time	8
5.5 Abort Time	8
5.6 Alarm Cancel Time.....	8
5.7 Quick Arming.....	8
5.8 Forced Arming.....	9
5.9 Restart Exit.....	9
5.10 Piezo Beeps	9
5.11 Trouble Beeps	9
5.12 Panic Alarm.....	9
5.13 Swinger Stop.....	9
5.14 Cross Zoning.....	9
5.15 Supervision Interval.....	9
5.16 AUX Button.....	9
5.17 Jamming Detection.....	9
5.18 Two-Way Voice	10
5.19 PGM / X-10 Time.....	10
5.20 Lighting Lockout Time	10
5.21 Latchkey Arming.....	10
5.22 "Not Active" Time.....	10
5.23 Back Lighting.....	10
5.24 Duress Alarm (ambush)	10
5.25 Piezo Siren.....	10
6. DEFINING COMMUNICATION PARAMETERS	11
6.1 Preliminary Guidance	11
6.2 Dialing Method	12
6.3 Phone Line Test Interval.....	13
6.4 First Central Station Telephone	13
6.5 First Account No.	13
6.6 Second Central Station Telephone.....	13
6.7 Second Account No.....	13
6.8 Report Format.....	13
6.9 4/2 Pulse Rate	13
6.10 Events Reported to Central Stations	13
6.11 Dialing Attempts	13
6.12 First Private Telephone No.	13
6.13 Second Private Telephone No.....	14
6.14 Third Private Telephone No.....	14
6.15 Telephone Message Type	14
6.16 Private Tel. Dialing Attempts	14
6.17 Events Reported to Private Telephones.....	14
6.18 Telephone Acknowledge	14
6.19 Pager Telephone Number	14
6.20 Pager's PIN No.....	14
6.21 Reporting to a Pager	14
6.22 Recent Closure.....	14
6.23 Remote Access	14
6.24 Downloader Code.....	15
7. DEFINING OUTPUT PARAMETERS	15
7.1 Preliminary Guidance	15
7.2 PGM Output Control	16
7.3 Controlling the X-10 Units.....	16
8. RECORDING SPEECH	17
8.1 Mode Description and Activation	17
8.2 Recording Procedure.....	17
9. DIAGNOSTIC TEST	17
9.1 Mode Description and Activation	17
9.2 Test Procedure	18
10. USER FUNCTIONS	18
11. READING THE EVENT LOG	18
11.1 Event Log Description	18
11.2 Reading Procedure.....	19
11.3 Erasing the Event Log	19
APPENDIX A. EVENT CODES	20

Important Message to the Installer

If you re-program a system already in use, all previous system status will be erased upon quitting the installer menu. Be sure to conduct a full walk test, including all windows and doors, to allow the control panel to re-capture the system status.

1. INTRODUCTION

1.1 General Guidance

We recommend to program the PowerMax on the work bench before actual installation. Operating power may be obtained from the backup battery or from the AC mains.

The installer's menu is accessible only to those who know the installer's code, which is **9→9→9→9** by factory default.

Obviously, you are expected to use this code only once for gaining initial access, and replace it with a secret code known only to yourself (see Section 2).

You will mainly use 5 control pushbuttons throughout the entire programming process:

	- to advance within a given menu.
	- to retreat within a given menu.
	- to go down one level in the programming structure or to confirm data.
	- to go up one level in the programming structure.
	- instant return to the installer menu (top level).

The sounds you will hear while programming are:

	- Single beep , heard whenever a key is pressed.
	- Double beep , indicates automatic return to the normal operating mode (by timeout).
	- Triple beep (once per minute), indicates a state of trouble.
	- Happy Melody (- - - —), indicates successful completion of an operation.
	- Sad Melody (— — —), indicates a wrong move or rejection.

1.2 Accessing the Installer's Menu

To access the installer's menu and navigate within it, refer to Figures 1 and 2 and proceed as follows:

A. Click the **<NEXT>** button until the display reads:

INSTALLER MODE

B. Click **<OK>** to select the installer's mode. The control panel will prompt you for the installer code.

C. Enter the valid installer code (**9→9→9→9**) if this is the first time you access the installer menu. The "Happy Tune" will sound if the code is correct and the display will change to:

1. NEW INSTL CODE

You have now gained access to the first item on the installer menu. Detailed instruction on how to deal with each item is given in sections 2 through 10 below.

Note: At this point refer to Figure 2, that takes over where Figure 1 left off.

D. Click **<NEXT>** to go up in menu item numbers and **<BACK>** to go down in menu item numbers.

E. To quit the installer's menu, click **<AWAY>**. This will take you directly to "**<OK> TO EXIT**".

F. Click **<OK>** to return to the normal operating mode.

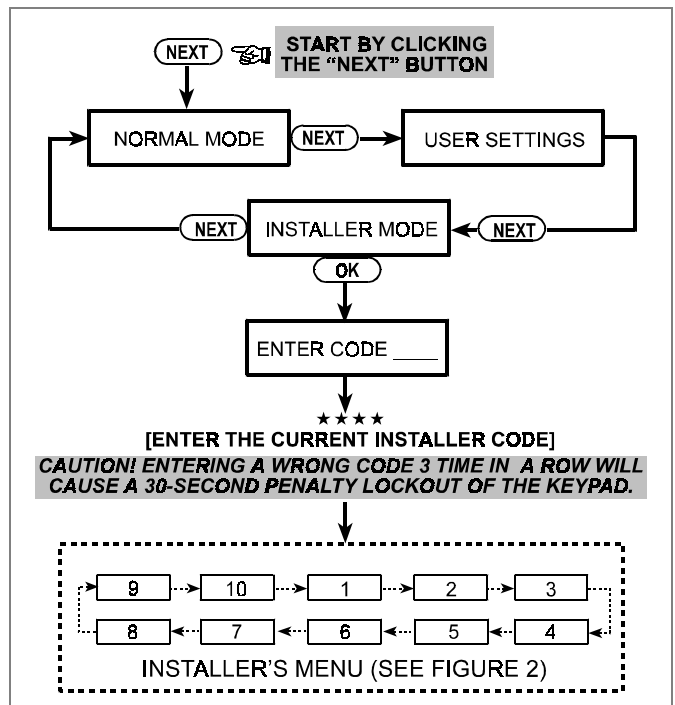

Figure 1. Gaining Access to the Installer's Menu

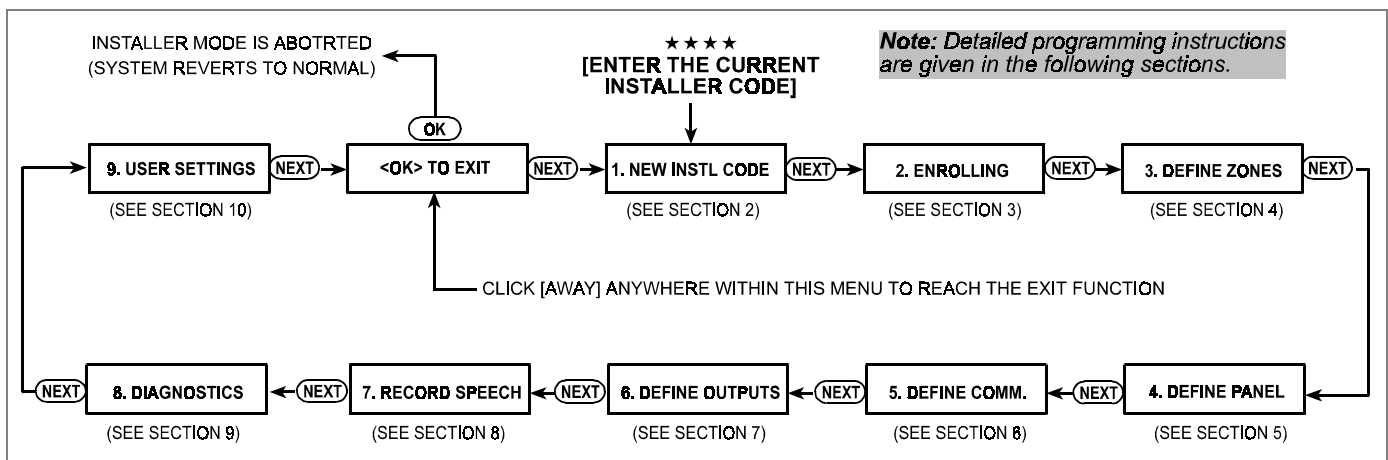

Figure 2. Navigating within the Installer Menu

2. SETTING A NEW INSTALLER CODE

A. Having successfully gained access to the installer menu (see Section 1), the display will read:

1 . NEW INSTL CODE

B. To change the installer code, click <OK>. The old code will appear (the factory default if this is the first change):

INST . CODE 9999

The cursor will flash on the first digit of the code.

C. Enter a new 4-digit code. After entering the 4th digit, the cursor will stop flashing.

Attention! Do not use "0000" - this code is invalid.

D. Click <OK>. The "Happy Tune" will sound and the display will revert to:

1 . NEW INSTL CODE

E. You may now click <NEXT> or <BACK> to select any other item on the installer's menu.

3. ENROLLING WIRELESS DEVICES AND KEYFOB TRANSMITTERS

3.1 General Guidance

The ENROLLING mode has two sub-modes:

- ENROLL WL DEVICE (wireless devices)
- ENROLL KEYFOB (multi-button CodeSecure transmitters)

Refer to Paragraphs 3.2 and 3.3 for enrolling procedures.

Attention! CodeSecure transmitters are mainly used for arming/disarming and can not be enrolled to zones. For enrolling to zones, use only non-CodeSecure wireless devices.

3.2 Wireless Devices

Wireless devices include various wireless PowerCode detectors and hand-held special-task transmitters. Your control panel must recognize the unique identification code (ID) of each such device in order to supervise them, receive their signals and respond accordingly.

Before anything else, gather all the devices that you intend to enroll, and make sure they all have batteries installed.



- The lens at the front of PIR and dual-technology sensors should be masked to prevent inadvertent transmission.

- Use rubber bands to bind magnetic contact transmitters together with their magnets, to prevent them from sending out alarm transmissions.

To enroll wireless devices, go through the following steps:

A. Upon gaining access to the installer menu (see Section 1), the display will read "1. NEW INSTL CODE".

B. Click <NEXT>. The enrolling mode will be selected and the display will show:

2 . ENROLLING

C. Click <OK> to select the "enroll wireless devices" sub-mode. The display will change to:

ENROLL WL DEVICE

D. Click <OK> again. The display will read:

Zone No : █ _

E. Suppose that the wireless device you are about to enroll is to be installed in Zone No. 4. Assuming that zone No. 4 is free - no device has yet been enrolled to it, just enter <0>⇒<4>. The display will change to:

Zone No : 04

The clear space at the far right tells you that the zone is free - no wireless device has been enrolled to it as yet.

F. Click <OK>. The display will prompt you to initiate a transmission from the chosen wireless device:

TRANSMIT NOW

G. Initiate transmission from the chosen device by:

- Removing the mask from the lens of the PIR motion detector, or
- Separating the magnet from the magnetic contact sensor, or
- Pressing the button of the hand-held miniature transmitter, or
- Pressing the test button of the smoke detector.

H. In response to the transmitted signal, the "Happy Tune" (- - - —) will sound and the display will change to:

Zone No : 04 █

A dark box will appear at the far right, indicating that the chosen device has been enrolled to Zone No. 4.

Note: If the same device is already enrolled to another zone, the "Happy Tune" will sound twice in succession.

I. From this point on, you may continue in several different directions:

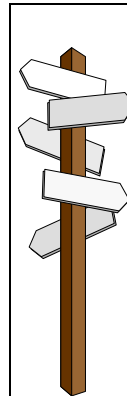

- If you wish to enroll another device to another zone, select the other zone by:
 - Clicking <NEXT> to go up (5→6→7.....)
 - Clicking <BACK> to go down (3→2→1.....)
 - Clicking <HOME> → <desired zone #>.

After that, proceed as in the example above.

- To delete a device ID, refer to Para. 3.4.
- To select the **Enroll Keyfob** sub-mode, click <HOME> and then <NEXT>.
- To return to the main menu, click <AWAY>.

This will bring back the display:

<OK> TO EXIT

You may now review and select any other mode on the installer's menu (by clicking <NEXT> or <BACK>).

3.3 Keyfob Transmitters

Keyfob transmitters are multi-button wireless units of the CodeSecure™ type. Eight system users carry them on their person to exercise better, quicker and safer control over various system functions. Your control panel must recognize the unique identification code (ID) of each such keyfob in order to respond to commands transmitted by them.

Before anything else, gather up all keyfob units you intend to enroll, and make sure they all have batteries installed.

Keyfob transmitter enrolling involves the following steps:

A. Perform Steps A through C in Para. 3.2 above, until the display reads:

ENROLL WL DEVICE

B. Click <NEXT>. The display will read:

ENROLL KEYFOB

C. Click <OK>. The display will read:

Keyfob No: _

D. Suppose that the Keyfob you are about to enroll is to be designated as Keyfob No. 5. Assuming that memory location No. 5 is free - no keyfob has yet been enrolled to it - click the <5> key. The display will change to:

Keyfob No: 5

The clear space at the far right tells you that the memory location is free.

E. Click <OK>. The display will prompt you to initiate a transmission from the chosen wireless device:

TRANSMIT NOW

F. Initiate a transmission from the chosen keyfob by pressing any one of its pushbuttons. In response, the "Happy Tune" (- - - —) will sound and the display will change to:

Keyfob No: 5

A dark box will appear at the far right, indicating that the chosen Keyfob has been enrolled as Keyfob No. 5.

Note: If the same keyfob is already enrolled elsewhere, the "Happy Tune" will sound twice in succession.

G. From this point on, you may continue in several different directions:

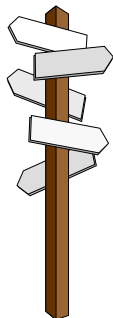

- If you wish to enroll another keyfob, select the desired number by:
 - Clicking <NEXT> to go up (6→7→8.....)
 - Clicking <BACK> to go down (4→3→2.....)
 - Clicking <HOME> → <desired zone #>.

After that, proceed as in the example above.

- To delete keyfob IDs, refer to Para. 3.4.
- To return to the main menu, click <AWAY>. This will bring back the display:

<OK> TO EXIT

You may now review and select any other mode on the installer's menu (by clicking <NEXT> or <BACK>).

3.4 Deleting Device and Keyfob IDs

Occupied zones or keyfob memory locations must be cleared (enrolled ID must be deleted) before enrolling a new ID. To delete an existing ID, proceed as follows:

A. Select the desired zone or memory location. If, for example you selected **Zone No. 15**, or **keyfob No. 8**, the display will read:

Zone No. 15

or, in the other case:

Keyfob No. 8

B. Click <OK>. The display will change to:

<OFF> to delete

C. Click <OFF>. The display will change to:

Zone No. 15

or, in the other case:

Keyfob No. 8

Note that the dark box at the far right has disappeared. It is now possible to enroll a new ID. It is also possible to leave the cleared zone or memory location free, and simply exit to the main menu.

4. DEFINING ZONE TYPES

4.1 Preliminary Guidance

This mode allows you to attribute one of 9 zone types to any one of the 29 wireless zones offered by the PowerMax. In addition it allows you to assign a name to each zone and determine whether the zone will operate as a chime zone while the system is in the disarmed state.

A list of factory defaults is printed on the following page. You may fill out the blank columns even before you start and proceed to program according to your own list.

To reach the DEFINE ZONES mode, proceed as follows:

A. Upon gaining access to the installer menu (see Section 1), the display will read "1. NEW INSTL CODE".

B. Click <NEXT> twice. The 3rd mode will be selected:

3. DEFINE ZONES

Should you wish to get an overall view of the entire zone definition process, refer to Figure 3. You may even use the chart as your only guide along the programming process, instead of going through the written step-by-step procedure.

Remember!

1. A delay zone is also a perimeter zone by definition.
2. All interior zones become follower zones during the exit and entry delays.

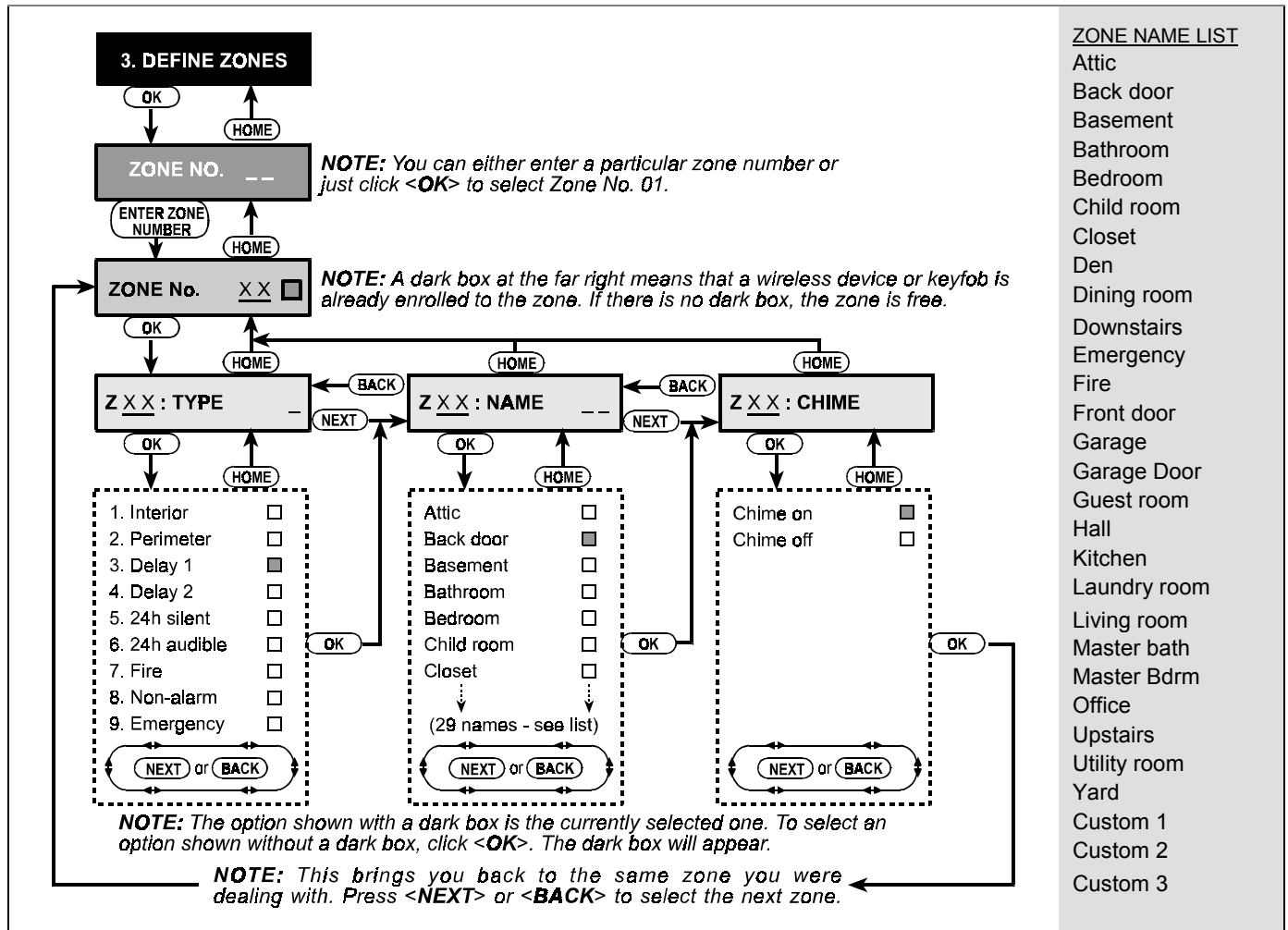

Figure 3. DEFINE ZONES Flow Chart

4.2 Zone Definition Procedure

Once "3. DEFINE ZONES" is viewed, proceed as follows:

A. Click <OK>. The display will read:

Zone No. --

B. Suppose that you wish to define (or re-define) Zone No. 7. All you have to do is select the zone by entering <0>=><7>, thereby changing the display to:

Zone No. 07 []

If there is no dark box at the far right, the zone has not learned a device ID as yet. If there is a dark box, the zone is already linked to a specific wireless device.

C. Click <OK>. The display will read:

Z 07 : TYPE

D. You can now enter the number of a specific zone definition (see list in Figure 3) and click <OK>. If, for example, you enter <5>=><OK>, the display will read:

5.24h silent

Note: If you click <OK> without entering a number, the display will show the current definition of the selected zone, with a dark box at the far right. You may then review all definitions by clicking <NEXT> repeatedly.

E. To accept the definition on display, click <OK>. A dark box will appear at the far right:

5.24h silent

F. Click <OK> once more to confirm. The "Happy Tune" will sound, and your selection will be memorized. The display will then change to:

Z 0 7 : N A M E

G. At this point, enter the serial number of the zone name you wish to attach to zone No. 7 from the list of 29 available names (see list in Figure 3).

Note: If you click <OK> without entering a number, the display will show the current name of the selected zone, with a dark box at the far right. You may then review all names by clicking <NEXT> repeatedly.

H. If you enter a number (say 13), the display will read:

Front door

I. Click <OK> to accept this name - a dark box will appear at the far right. Click <OK> again to confirm. The "Happy Tune" will sound, your selection will be saved and the display will change to:

Z 0 7 : C H I M E

J. Click <OK>. You are about to determine whether this zone will be a chime zone or not. The display will read:

chime on

or: chime off

You can toggle the display between CHIME ON and CHIME OFF by clicking <NEXT>.

K. Click <OK> once if you approve of the already selected option - the "Happy Tune" will sound. Alternatively, click <OK> twice while the other option is viewed. The "Happy Tune" will sound and the display will revert to:

Zone No. 07

L. From this point on, you may continue in several different directions:



- Click <NEXT> to go up (8→9→10.....)

- Click <BACK> to go down (6→5→4.....)

Repeat Steps C through K above for all other zones that you plan to use.

• To return to the main menu, click <AWAY>. This will get you back to:

<OK> TO EXIT

You may now review and select any other mode on the installer's menu (by clicking <NEXT> or <BACK>).

DEFAULT AND PROGRAMMED ZONE DEFINITIONS

Zone No.	Zone Type		Zone Name		Chime Y/N? *
	Default	Programmed	Default	Programmed	
1	Delay 1		Front door		
2	Delay 1		Garage		
3	Delay 2		Garage door		
4	Perimeter		Back door		
5	Perimeter		Child room		
6	Interior		Office		
7	Interior		Dining room		
8	Perimeter		Dining room		
9	Perimeter		Kitchen		
10	Perimeter		Living Room		
11	Interior		Living Room		
12	Interior		Bedroom		
13	Perimeter		Bedroom		
14	Perimeter		Guest Room		
15	Interior		Master Bedroom		
16	Perimeter		Master Bedroom		
17	Perimeter		Laundry room		
18	Perimeter		Master Bathroom		
19	Perimeter		Basement		
20	Fire		Fire		
21	Fire		Fire		
22	Emergency		Emergency		
23	Emergency		Emergency		
24	24 h / silent		Basement		
25	24 h / silent		Office		
26	24 h / audible		Attic		
27	24 h / audible		Den		
28	non-alarm		Yard		
29	non-alarm		Hall		
30	non-alarm		Utility room		

* **Note:** All zones are non-chime by default. Enter your own choice in the last column and program accordingly.

5. DEFINING CONTROL PANEL PARAMETERS

5.1 Preliminary Guidance

A. Mode description

This mode allows you to customize the control panel and adapt its characteristics and behavior to the requirements of the particular user.

Should you wish to get an overall view of the entire programming process, refer to the programming chart in Figure 4. You may even use the chart as your only guide along the programming process, instead of going through the written step-by-step procedure.

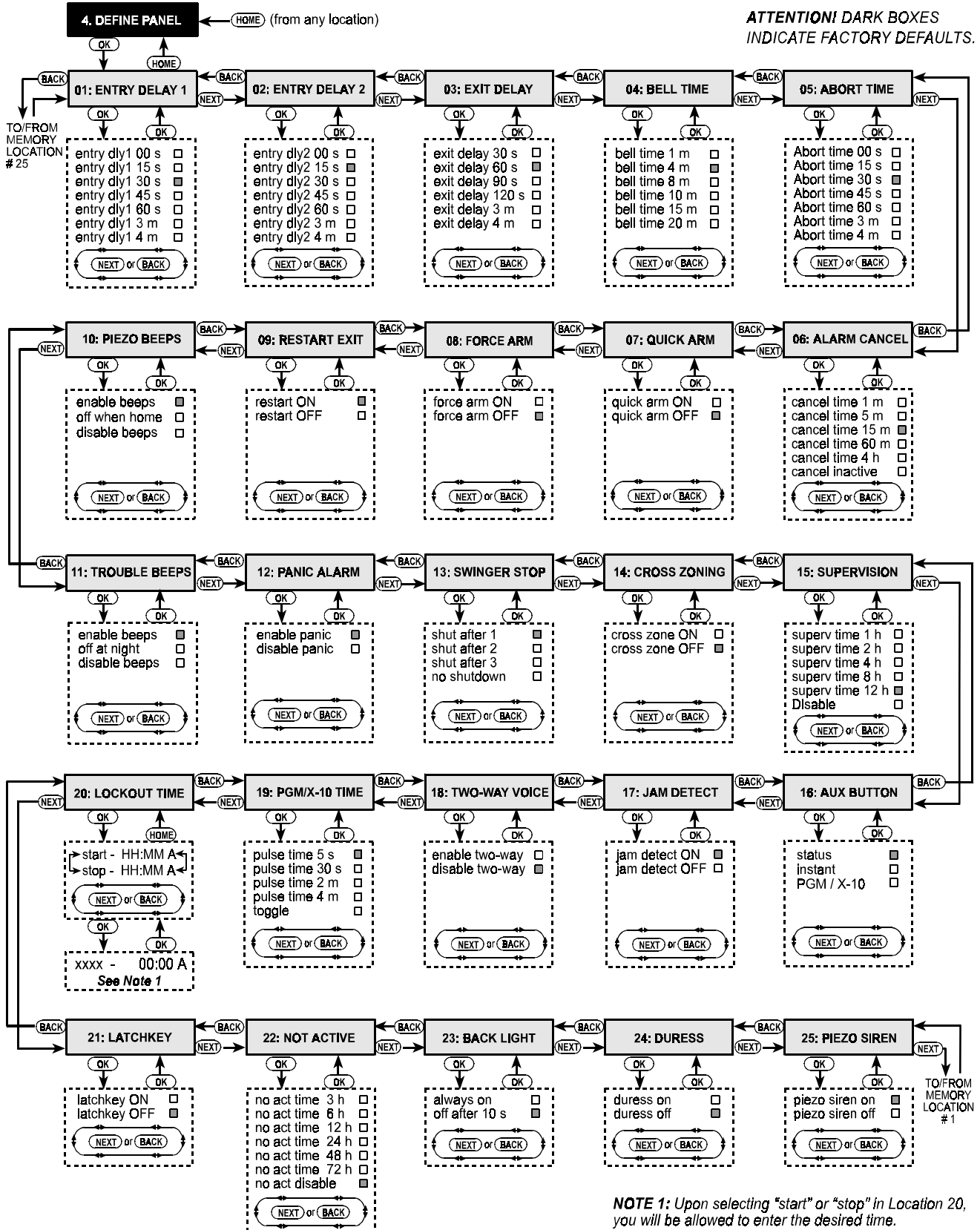

Figure 4. DEFINE PANEL Flow Chart

B. Gaining access to the “Define Panel” Memory Locations

To reach the DEFINE PANEL mode, proceed as follows:

- Upon gaining access to the installer menu (see Section 1), the display will read “1. NEW INSTL CODE”.
- Click <NEXT> until the 4th mode is displayed:

4 . DEFINE PANEL

- Click <OK>. The first memory location will be selected and displayed:

01 : ENTRY DELAY 1

- Click <NEXT> or <BACK> until you reach the memory location you wish to access (see rectangles 01 to 25 in Figure 4).

C. Programming Method

The “multiple choice” programming method is applied here. Once a memory location is selected, its number and name are displayed as shown in the following example:

03 : EXIT DELAY

When you click <OK>, the currently saved option will be displayed with a **dark selection box** at the far right of the display:

exit delay 45s

If you approve of this option, click <OK>. The “Happy Tune” will sound and the display will revert to the number and name of the presently selected memory location.

If you do not approve, review the other options by clicking <NEXT> or <BACK> repeatedly. Options that are not saved will have a clear space at the far right, as shown:

exit delay 90s

To select an option, click <OK>. A dark box will appear at the far right of the display.

Clicking <OK> once more will cause your selection to be saved - the “Happy tune” will sound and the number and name of the presently selected memory location will be re-displayed. Click <NEXT> or <BACK> to select another memory location.

5.2 Entry Delays

Two different entry delays allow the user to enter the protected site (while the system is in the armed state) via 2 specific doors and routes without causing an alarm.

Following entry, the user must disarm the control panel before the entry delay expires. Slow-rate warning beeps will start sounding once the door is opened. This will continue until the last 10 seconds of the delay, throughout which the beeping rate will increase.

Locations No. 1 (entry delay 1) and 2 (entry delay 2) allow you to program the length of these delays. Available options for each delay are: **00, 15, 30, 45, 60, 180 and 240** seconds.

In UL installations, these delays must be 45 s max.

Upon selecting Location No. 01, The display will read:

01 : ENTRY DELAY 1

select the desired option as outlined in Para. 5.1 C above. When done, Click <NEXT> to select Location No. 2. Continue the same way as in location 1. When done, Click <NEXT> to select Location 3.

5.3 Exit Delay

An exit delay allows the user to arm the system and leave the protected site via specific routes and doors without causing an alarm. Slow-rate warning beeps will start sounding once the arming command has been given. This will continue until the last 10 seconds of the delay, throughout which the beeping rate will increase.

Location No. 3 allows you to program the length of the exit delay. Available options are: **30, 60, 90, 120, 180 and 240** seconds.

Upon selecting Location 03, the display will read:

03 : EXIT DELAY

Select the desired option as outlined in Para. 5.1 C above.

5.4 Bell Time

Here you select the length of time the bell (or siren) is allowed to function upon alarm. The bell time starts upon activation of the siren. Once the bell time expires, the siren is automatically shut down.

Available options: **01, 04, 08, 10, 15 and 20** minutes.

In UL installations, set bell time to 4 minutes minimum.

Upon selecting Location 04, the display will change to:

04 : BELL TIME

Select the desired option as outlined in Para. 5.1 C above.

5.5 Abort Time

Here you select the length of time allowed by the system to abort an alarm. The PowerMax is programmed to provide an “abort interval” that starts upon detection of an alarm. During this interval, the buzzer sounds a warning but the siren remains inactive and the alarm is not reported. If the user disarms the system within the allowed abort interval, the alarm will be aborted.

Available options: **00, 15, 30, 45, 60, 180, 240** seconds.

Upon selecting Location 05, the display will change to:

05 : ABORT TIME

Select the desired option as outlined in Para. 5.1 C above.

5.6 Alarm Cancel Time

Here you determine the “cancel alarm” period that starts upon reporting an alarm to the central station. If the user disarms the system within that time period, a “cancel alarm” message will be sent to the central station.

The options are: **1, 5, 15, 60 minutes, 4 hours** and also **cancel inactive**.

Upon selecting Location 06, the display will change to:

06 : ALARM CANCEL

Select the desired option as outlined in Para. 5.1 C above.

5.7 Quick Arming

Here you determine whether the user will be allowed to perform quick arming or not. Once quick arming is permitted, the control panel does not request a user code before it actually arms the system.

The two options are: **quick arm on** and **quick arm off**.

Upon selecting Location 07, the display will change to:

07 : QUICK ARM

Select the desired option as outlined in Para. 5.1 C above.

5.8 Forced Arming

Here you determine whether the user will be allowed to perform forced arming or not. If forced arming is permitted, the control panel will automatically bypass zones that were open throughout the exit delay (but not delay zones). If forced arming is not permitted, "NOT READY" will be displayed and arming will be refused (the "Sad Melody" will sound).

The two options are: **force arm ON** and **force arm OFF**.

In UL installations, OFF must be selected (no forced arming).

Upon selecting Location 08, the display will change to:

08 : FORCE ARM

Select the desired option as outlined in Para. 5.1 C above.

5.9 Restart Exit

Here you determine whether the exit delay will restart if the exit / entry door is reopened before the exit delay expires. Restarting the exit delay is helpful if the user re-enters immediately after going out to retrieve an item that he left behind.

The two options are: **restart ON** and **restart OFF**.

Upon selecting Location 09, the display will change to:

09 : RESTART EXIT

Select the desired option as outlined in Para. 5.1 C above.

5.10 Piezo Beeps

Here you determine whether warning beeps will sound or will be muted throughout the exit and entry delays. An additional option is to mute the warning beeps only when the system is armed "HOME".

Three options are available: **enable beeps**, **off when home** and **disable beeps**.

Upon selecting Location 10, the display will change to:

10 : PIEZO BEEPS

Select the desired option as outlined in Para. 5.1 C above.

5.11 Trouble Beeps

Under trouble conditions, the sounder emits a series of 3 short beeps once per minute. Here you determine whether this special beeping sequence will be active, inactive, or just inactive at night (the range of "night" hours is defined in the factory).

The 3 options are: **enable beeps**, **off at night (8 PM through 7 AM)** and **disable beeps**.

Upon selecting Location 11, the display will change to:

11 : TROUBLE BEEPS

Select the desired option as outlined in Para. 5.1 C above.

5.12 Panic Alarm

Here you determine whether the user will be allowed to initiate a panic alarm by simultaneous pressing of the two panic buttons (on the keypad) or away + home (on a keyfob transmitter).

The two options are: **enable panic** and **disable panic**.

Upon selecting Location 12, the display will change to:

12 : PANIC ALARM

Select the desired option as outlined in Para. 5.1 C above.

5.13 Swinger Stop

Here you determine how many times each zone is allowed to initiate an alarm within a single arming period. If the number of alarms from a specific zone exceeds the number programmed in this location, the control panel will automatically bypass the zone to prevent recurrent siren noise and nuisance reporting to the central station. The zone will remain bypassed until disarming.

The available options are: **shut after 1**, **shut after 2**, **shut after 3** and **no shutdown**.

In UL installations, No Shutdown must be selected.

Upon selecting Location 13, the display will change to:

13 : SWINGER STOP

Select the desired option as outlined in Para. 5.1 C above.

5.14 Cross Zoning

Here you determine whether cross zoning will be active or inactive. Cross zoning is a method used to counteract false alarms - an alarm will not be initiated unless two adjacent zones are violated within a 30-second time limit. This feature is active only when arming AWAY and only with zone couples from zone No. 20 up (20 and 21, 22 and 23, etc.). You may use any one of these zone couples to create a "cross-zoned" area.

The options are: **cross zone ON** and **cross zone OFF**.

Upon selecting Location 14, the display will change to:

14 : CROSS ZONING

Select the desired option as outlined in Para. 5.1 C above.

5.15 Supervision Interval

Here you determine the time limit for reception of supervision reports from supervised wireless devices. If any device does not report at least once within the selected time limit, an "INACTIVITY" alert will be initiated.

The options are: **1, 2, 4, 8, 12 hours** and **disable**.

In UL installations, the interval must not exceed 4 h.

Upon selecting Location 15, the display will change to:

15 : SUPERVISION

Select the desired option as outlined in Para. 5.1 C above.

5.16 AUX Button

Here you select the function of the AUX button on keyfob transmitters. Three options are offered:

Status: Pressing the AUX button will cause the control panel's voice module to announce the system status.

Instant: Pressing the AUX button while the exit delay is in progress will cause the system to arm "instant" (the entry delay is cancelled).

PGM / X-10: Pressing the AUX button will activate the PGM output or X-10 units (see further programming under "DEFINE OUTPUTS").

Upon selecting Location 16, the display will change to:

16 : AUX BUTTON

Select the desired option as outlined in Para. 5.1 C above.

5.17 Jamming Detection

Here you determine whether jamming (interfering transmissions) on the radio channel used by the system will be detected and reported or not.

The options are: **jam detect ON** and **jam detect OFF**.
If the jam detect ON option is selected, the system will not allow arming under jamming conditions..

Upon selecting Location 17, the display will change to:

17 : JAM DETECT

Select the desired option as outlined in Para. 5.1 C above.

5.18 Two-way Voice

Here you determine whether two-way voice communication will be allowed or not.

The two options are: **enable 2-way** and **disable 2-way**.

Upon selecting Location 18, the display will change to:

18 : TWO - WAY VOICE

Select the desired option as outlined in Para. 5.1 C above.

5.19 PGM / X-10 Time

Here you determine the pulse duration (length of activation time) for the PGM output and the X-10 units.

The available options are: **5 s, 30 s, 2 min, 4 min and toggle**. "Toggle" means that one command will activate the output and the following command will deactivate it.

Upon selecting Location 19, the display will change to:

19 : PGM / X - 10 TIME

Select the desired option as outlined in Para. 5.1 C above.

5.20 Lighting Lockout Time

This memory location is different from the others, because you do not select one of several options. Here you enter daytime limits between which lighting devices will be off, regardless of other settings or commands. **Lockout Time** takes precedence over timed activation for the X-10 units and the PGM output (see Section 7). In case of discrepancy, the lockout prevails.

Upon selecting Location 20, the display will change to:

20 : LOCKOUT TIME

A. Click <OK>. The display will read:

start - HH:MM A

B. Click <OK>. The display will change to:

start - 00:00 A

C. Enter the time at which you wish the lockout state to begin (usually at dawn).

Note: AM and PM are selected by clicking "#" and "★", respectively.

Once the viewed time is correct, regardless of the cursor position, click <OK> twice. The display will change to:

stop - HH:MM P

D. Click <OK>. The display will change to:

stop - 00:00 P

E. Enter the time at which you wish the lockout state to end (usually at dusk). With the correct time on display, regardless of the cursor position, click <OK> twice. The display will revert to "stop - HH:MM P".

F. Click <HOME> to return to "20: LOCKOUT TIME".

5.21 Latchkey Arming

Here you determine whether the system can be armed in the latchkey mode. If the system is armed this way, a "latchkey" message will be sent to specific telephones upon disarming by a "latchkey user" (users 5 through 8 or keyfob transmitters 5 through 8). This mode is useful when parents at work want to be informed of a child's return from school.

The options are: **Latchkey ON** and **Latchkey OFF**.

Upon selecting Location 21, the display will change to:

21 : LATCHKEY

Select the desired option as outlined in Para. 5.1 C above.

5.22 "Not Active" Time

Here you determine the time limit for reception of signals from sensors used to monitor the activity of sick, elderly or crippled people. If no device detects and reports movement at least once within the defined time limit, a "not-active" alert will be initiated.

The options are: **3, 6, 12, 24, 48, 72 hours** and **canceled**.

Upon selecting Location 22, the display will change to:

22 : NOT ACTIVE

Select the desired option as outlined in Para. 5.1 C above.

5.23 Back Lighting

Here you determine whether the back lighting of the keypad will remain on at all times or will come on when a key is pressed and go off within 10 seconds if no further keystrokes are sensed.

The two options are: **always on** and **off after 10 s**.

In UL installations, "off after 10 s" must be selected to save battery power.

Upon selecting Location 23, the display will change to:

23 : BACK LIGHT

Select the desired option as outlined in Para. 5.1 C above.

5.24 Duress Alarm (ambush)

Here you determine whether the duress feature will be active or inactive. A duress message can be sent to the central station if the user is forced to disarm the system under violence or menace. To initiate a duress message, the user must enter the special factory-programmed duress code - **2580**.

Note: The system does not allow the user to program this particular code as a regular user code.

The two options are: **duress on** and **duress off**.

Upon selecting Location 24, the display will change to:

24 : DURESS

Select the desired option as outlined in Para. 5.1 C above.

5.25 Piezo Siren

Here you determine whether the piezo siren built into the control cabinet will sound or not upon alarm. Ask the user whether he prefers it to sound or to be silent.

The two options are: **piezo siren on** and **piezo siren off**.

Upon selecting Location 25, the display will change to:

25 : PIEZO SIREN

Select the desired option as outlined in Para. 5.1 C above.

Having thus completed a full cycle of all 25 panel attributes, you may now continue by programming the communication parameters (see Section 6), or you may select any other item on the installer's menu (see opposite column).



If at this point you wish to return to the installer's menu, click **<AWAY>**. This will get you back to:

<OK> TO EXIT

You may now review and select any other mode on the installer's menu (by clicking **<NEXT>** or **<BACK>**).

6. DEFINING COMMUNICATION PARAMETERS

6.1 Preliminary Guidance

A. Mode description

This mode allows you to adapt the telephone communication parameters to the local requirements.

There are two kinds of memory locations in this sub-mode, each of which requires a different programming method:

- **Multiple Choice Locations:** these memory locations allow you to choose one of several options (see C below for programming procedure)
- **Numerical Data Locations:** these memory locations accept a sequence of digits (phone number, account number etc - see D below for programming procedure).

Should you wish to get an overall view of the entire process, refer to the programming chart in Figure 5. You may even use the chart as your only guide along the programming process, instead of going through the written step-by-step procedure.

B. Accessing the "Define Comm" Memory Locations

- Upon gaining access to the installer menu (see Section 1), the display will read "1. NEW INSTL CODE".
- Click **<NEXT>** until the 5th mode is displayed:

5 . DEFINE COMM .

- Click **<OK>**. The first memory location will be selected and displayed:

01 : DIAL METHOD

- Click **<NEXT>** or **<BACK>** until you reach the memory location you wish to access (see rectangles 01 to 23 in Figure 5).

C. Programming Multiple Choice Locations

When a multiple choice location is selected, its number and name will be displayed as shown in this example:

07 : REPORT FORMAT

When you click **<OK>**, the currently saved option will be displayed with a **dark selection box** at the far right:

S I A

If you approve of this option, click **<OK>**. The "Happy Tune" will sound and the number and name of the present memory location will be re-displayed.

If you do not approve, review the other options by clicking **<NEXT>** or **<BACK>** repeatedly. Options that are not saved will have a clear space at the far right, as shown:

contact ID

To select an option that is not the currently saved one, click **<OK>**. A dark box will appear at the far right. Clicking **<OK>** once more will cause your selection to be saved -

the "Happy tune" will sound and the number and name of the present memory location will be re-displayed.

D. Programming Numerical Data Locations

When a numeric data location is selected, its number and name will be displayed as shown in this example:

03 : 1ST CNTR TEL

When you click **<OK>**, the currently saved number will be displayed, with a blinking cursor under the leftmost digit (if there is no number programmed, the display will be blank).

07 3 8 4 9 2 0 4

If you approve of the saved number, click **<OK>**. The "Happy Tune" will sound and the number as well as the name of the present memory location will be re-displayed.

If you do not approve, enter the new number (up to 16 digits). To erase undesired digits to the right of the cursor, click **<OFF>**.

With the correct number on display and the blinking cursor to the right of the last digit, click **<OK>**. The cursor will disappear.

Click **<OK>** once more. The new number will be saved - the "Happy tune" will sound and the number + name of the present memory location will be re-displayed.



When entering a series of digits, the following keys are useful:

- <Numeric keypad>** - to enter the number
- NEXT** - moves the cursor from left to right
- BACK** - moves the cursor from right to left
- OFF** - deletes everything after the cursor (to the right).

IMPORTANT: In telephone / pager number locations and account number locations, you may be required to enter hexadecimal digits. In telephone number locations, these digits are used as codes to control the dialer:

Hex. Digit	Keying Sequence	Code Significance
A	<#> => <0>	Dialer waits 5 seconds or waits for dial tone, whichever comes first and then dials.
B	<#> => <1>	Inserts an asterisk (*)
C	<#> => <2>	Inserts a pound sign (#)
D	<#> => <3>	Dialer waits 5 seconds for dial tone and goes on hook if none is received.
E	<#> => <4>	Not applicable in phone numbers
F	<#> => <5>	Not applicable in phone numbers

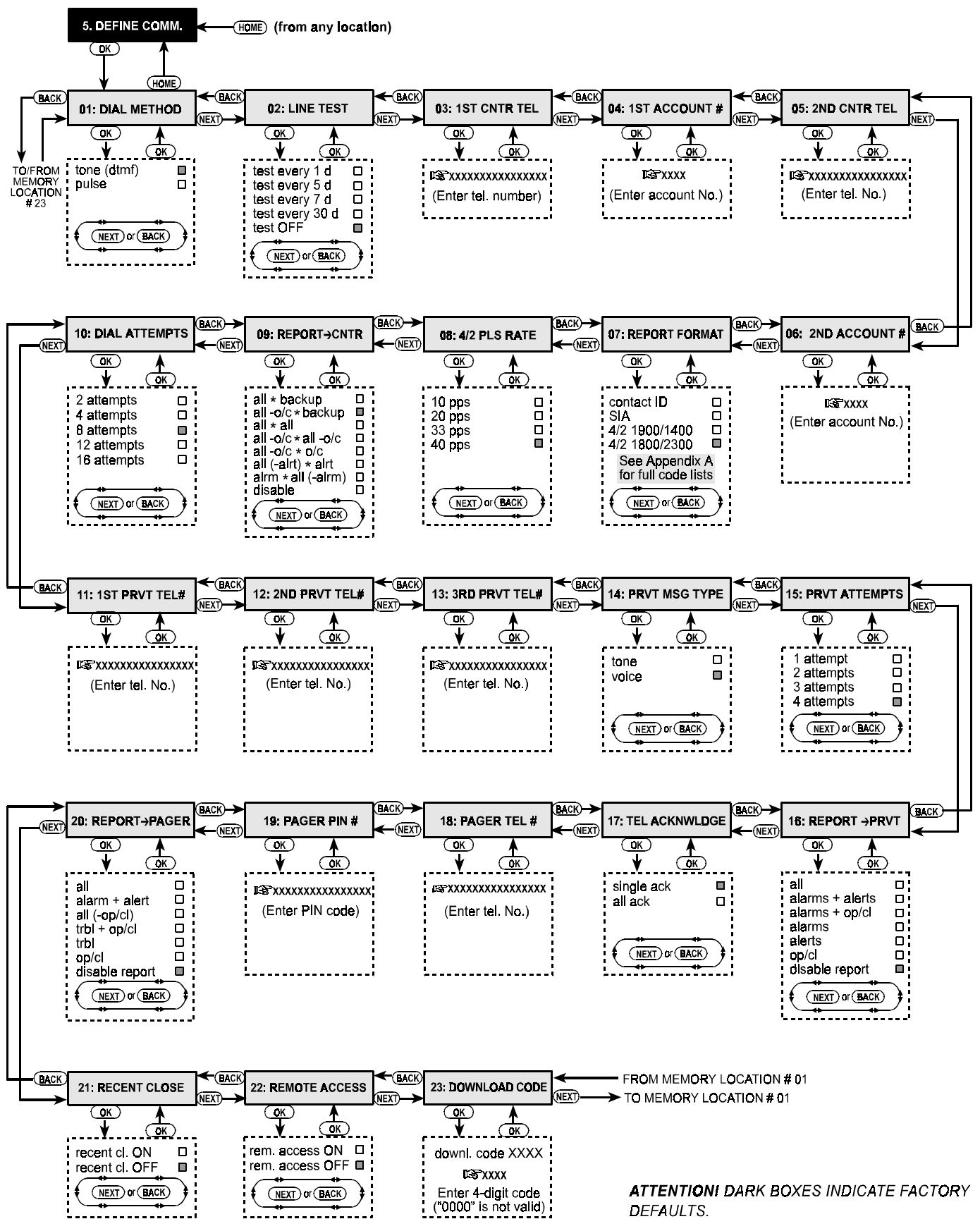

Figure 5. DEFINE COMM Flow Chart

6.2 Dialing Method

Here you determine the dialing method used by the automatic dialer built into the PowerMax control panel. The options are: **Pulse** and **DTMF**

Upon selecting Location 01, the display will read:

01: DIAL METHOD

Select the desired option as outlined in Para. 6.1 C above.

6.3 Phone Line Test Interval

Here you determine the time interval between consecutive tests of the telephone line. The control panel tests the line at regular intervals to verify that the telephone line is operational. However, be advised that the first test will take place 12 hours after you exit the installer mode.

The options are: **test every 1, 5, 7, 30 days** and **test off**.

Upon selecting Location 02, the display will change to:

02 : LINE TEST

Select the desired option as outlined in Para. 6.1 C above.

6.4 First Central Station Telephone

Here you program the telephone number of the first central station to which the PowerMax will report the event groups defined in memory location 09.

Upon selecting Location 03, the display will change to:

03 : 1ST CNTR TEL

Enter the first central station's telephone number (16 digits max.) as outlined in Para. 6.1 D above.

6.5 First Account No.

Here you enter the account number that will identify your specific alarm control system to the first central station. The number consists of 4 hexadecimal digits.

Upon selecting Location 04, the display will change to:

04 : 1ST ACCOUNT #

Enter the account no. as outlined in Para. 6.1 D above.

6.6 Second Central Station Telephone

Here you program the telephone number of the second central station to which the PowerMax will report the event groups defined in memory location 09.

Upon selecting Location 05, the display will change to:

05 : 2ND CNTR TEL

Enter the second central station's telephone number as outlined in Para. 6.1 D above.

6.7 Second Account No.

Here you enter the account number that will identify your particular alarm control system to the second central station. The account number consists of 4 hexadecimal digits.

Upon selecting Location 06, the display will change to:

06 : 2ND ACCOUNT #

Enter the account no. as outlined in Para. 6.1 D above.

6.8 Report Format

Here you select the reporting format used by the control panel to report events to central stations.

The options are: ■ **Contact-ID** ■ **SIA** ■ **4/2 1900/1400** ■ **4/2 1800/2300** (for code lists - see Appendix A).

Upon selecting Location 07, the display will change to:

07 : REPORT FORMAT

Select the desired option as outlined in Para. 6.1 C above.

6.9 4/2 Pulse rate

Here you select the pulse rate at which data will be sent to central stations if any one of the 4/2 formats has been selected in Location 07.

The options are: **10, 20, 33** and **40** pps

Upon selecting Location 08, the display will change to:

08 : 4 / 2 PLS RATE

Select the desired option as outlined in Para. 6.1 C above.

6.10 Events Reported to Central Stations

Here you determine which types of event will be reported to central stations. Due to lack of space in the display, abbreviations are used: alarm is "**alarm**", alert is "**alrt**" and open/close is "**o/c**". The asterisk (*) is a separator between events reported to **central station 1** and events reported to **central station 2**.

Messages are divided by type into three groups:

<u>GROUP</u>	<u>EVENTS REPORTED</u>
Alarms	Fire, Burglary, Panic, Tamper
Open/Close	Arming AWAY, Arming HOME, Disarming
Alerts	No-activity, Emergency, Latchkey

Group 1 has the highest priority and group 3 has the lowest priority.

The selectable options are shown in the following table:

<u>Plan name</u>	<u>Sent to center 1</u>	<u>Sent to center 2</u>
all * backup	All events	} All if center 1 } does not respond
all -o/c * backup	All but open/close	
all * all	All events	All events
all -o/c * all -o/c	All but open/close	All but open/close
all -o/c * o/c	All but open/close	open/close only
all (-alrt) * alrt	All but alerts	Alerts
alarm * all (-alarm)	Alarms	All but alarms
disable	Nothing	Nothing

Note: "All" means that all 3 groups are reported and also trouble messages - sensor / system low battery, sensor inactivity, power failure, jamming and communication failure.

Upon selecting Location 09, the display will change to:

09 : REPORT → CNTR

Select the desired option as outlined in Para. 6.1 C above.

6.11 Dialing Attempts

Here you determine how many times the communicator will dial the central station's number.

The options are: **2, 4, 8, 12,** and **16** attempts.

Attention! A maximum of 2 dialing attempts is permitted by the Australian Telecommunication Authority.

Upon selecting Location 10, the display will change to:

10 : DIAL ATTEMPTS

Select the desired option as outlined in Para. 6.1 C above.

6.12 First Private Telephone No.

Here you program the telephone number of the first private subscriber to which the system will report the event groups defined in Location 16.

Upon selecting Location 11, the display will change to:

11 : 1ST PRVT TEL #

Enter the first private subscriber's telephone number as outlined in Para. 6.1 D above.

6.13 Second Private Telephone No.

Here you program the telephone number of the second private subscriber to which the system will report the event groups defined in Location 16.

Upon selecting Location 12, the display will change to:

12 : 2ND PRVT TEL#

Enter the second private subscriber's telephone number as outlined in Para. 6.1 D above.

6.14 Third Private Telephone No.

Here is the place to program the telephone number of the third private subscriber to which the system will report the event groups defined in Location 16.

Upon selecting Location 13, the display will change to:

13 : 3RD PRVT TEL#

Enter the third private subscriber's telephone number as outlined in Para. 6.1 D above.

6.15 Telephone Message Type

Here you determine whether reporting to private telephone subscribers will be carried out by tone signals or by voice. The options are: **tone** and **voice**.

Upon selecting Location 14, the display will change to:

14 : TEL. MSG TYPE

Select the desired option as outlined in Para. 6.1 C above.

6.16 Private Tel. Dialing Attempts

Here you determine how many times the communicator will dial the called party's number (private telephone).

The options are: **1**, **2**, **3** and **4** attempts.

Attention! A maximum of 2 dialing attempts is permitted by the Australian Telecommunication Authority.

Upon selecting Location 15, the display will change to:

15 : PRVT ATTEMPTS

Select the desired option as outlined in Para. 6.1 C above.

6.17 Events reported to Private Telephones

Here you determine which event groups will be reported to private telephone subscribers.

The options are: all alarms + alerts alarms + op/cl alarms alerts op/cl disable report.

Note: "all" does not include trouble messages, which are not reported to private telephones.

Upon selecting Location 16, the display will change to:

16 : REPORT → TEL.

Select the desired option as outlined in Para. 6.1 C above.

6.18 Telephone Acknowledge

Here you determine whether the system will use the single acknowledge or the all-acknowledge mode when reporting to private telephones.

Note: In the single acknowledge mode, receiving an acknowledge signal from a single telephone is sufficient to consider the current event closed and call off the communication session. The remaining telephones serve for backup purposes only.

In the all acknowledge mode, an acknowledge signal must be received from each telephone before the current event is considered reported.

The options are: **single ack** and **all ack**.

Upon selecting Location 17, the display will change to:

17 : TELEPHONE ACK

Select the desired option as outlined in Para. 6.1 C above.

6.19 Pager Telephone Number

Here you program the telephone number of the pager to which the system will report (if any).

Upon selecting Location 18, the display will change to:

18 : PAGER TEL#

Enter the pager's phone number as in Para. 6.1 D above.

6.20 Pager's PIN Number

Here you enter the pager's PIN code - a digital sequence which is the pager's address. The paging company's computer needs this input for routing messages to the specific pager. The PIN sequence precedes any digital message that the PowerMax sends to the pager to report an event. It may include digits, pauses and special characters (* or #). Call the paging company to find out what the pager's PIN code should consist of.

Upon selecting Location 19, the display will change to:

19 : PAGER PIN #

Important! In this location, special characters can be entered as shown below:

To Insert	Keying Sequence	Character Displayed
*	<#> ⇒ <1>	B
#	<#> ⇒ <2>	C
5 sec pause	<#> ⇒ <3>	D

Enter the pager's PIN number (up to 16 digits, including special characters, depending on pager system protocol).

6.21 Reporting to a Pager

Here you determine which event groups will be reported to the pager.

The options are: all alarms + alerts all (- op/cl) trbl + op/cl trbl op/cl disable report

Upon selecting Location 20, the display will change to:

20 : REPORT → PAGER

Select the desired option as outlined in Para. 6.1 C above.

6.22 Recent Closure

Here you enable or disable the "recent closing" report, that is sent to the central station if an alarm occurs within 2 minutes from the expiry of the exit delay.

The options are: **recent close ON** and **recent close OFF**

Upon selecting Location 21, the display will change to:

21 : RECENT CLOSE

Select the desired option as outlined in Para. 6.1 C above.

6.23 Remote Access

Here you give or deny permission to access the system and exercise control from a remote telephone.

The options are: **rem. access ON** and **rem. access OFF**

Upon selecting Location 22, the display will change to:

22 : REMOTE ACCESS

Select the desired option as outlined in Para. 6.1 C above.

6.24 Downloader Code

Here you determine the 4-digit code used as a password for downloading data into the PowerMax memory.

Upon selecting Location 23, the display will change to:

23 : DOWNLOAD CODE

Enter the 4-digit code as outlined in Para. 6.1 D above.

Attention! Do not use "0000" - this code is invalid.

Having thus completed a full cycle of all 23 communication parameters, you may now continue by defining output parameters (see Section 7).

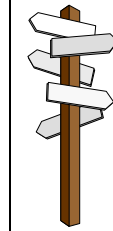

If at this point you wish to return to the installer's menu, click <AWAY>. This will get you back to:

<OK> TO EXIT

You may now review and select any other mode on the installer's menu (by clicking <NEXT> or <BACK>).

7. DEFINING OUTPUT PARAMETERS

7.1 Preliminary Guidance

A. Mode description

This mode allows you to select events and conditions under which the PGM (programmable) output and X-10 outputs will function.

There are two kinds of memory locations in this sub-mode, each of which requires a different programming method:

- **Multiple Choice Locations:** these memory locations allow you to choose one of several options (see C below for programming method)
- **Numerical Data Locations:** these memory locations accept digital data (a code, a time limit etc. - see D below for programming method).

Should you wish to get an overall view of the entire process, refer to the programming chart in Figure 6. You may even use the chart as your only guide along the programming process, instead of going through the written step-by-step procedure.

B. Gaining Access to the "Define Outputs" Mode

- Upon gaining access to the installer menu (see Section 1), the display will read "1. NEW INSTL CODE".
- Click <NEXT> until the 6th mode is displayed:

6 . DEFINE OUTPUTS

- Click <OK>. The display will show the first sub-mode:

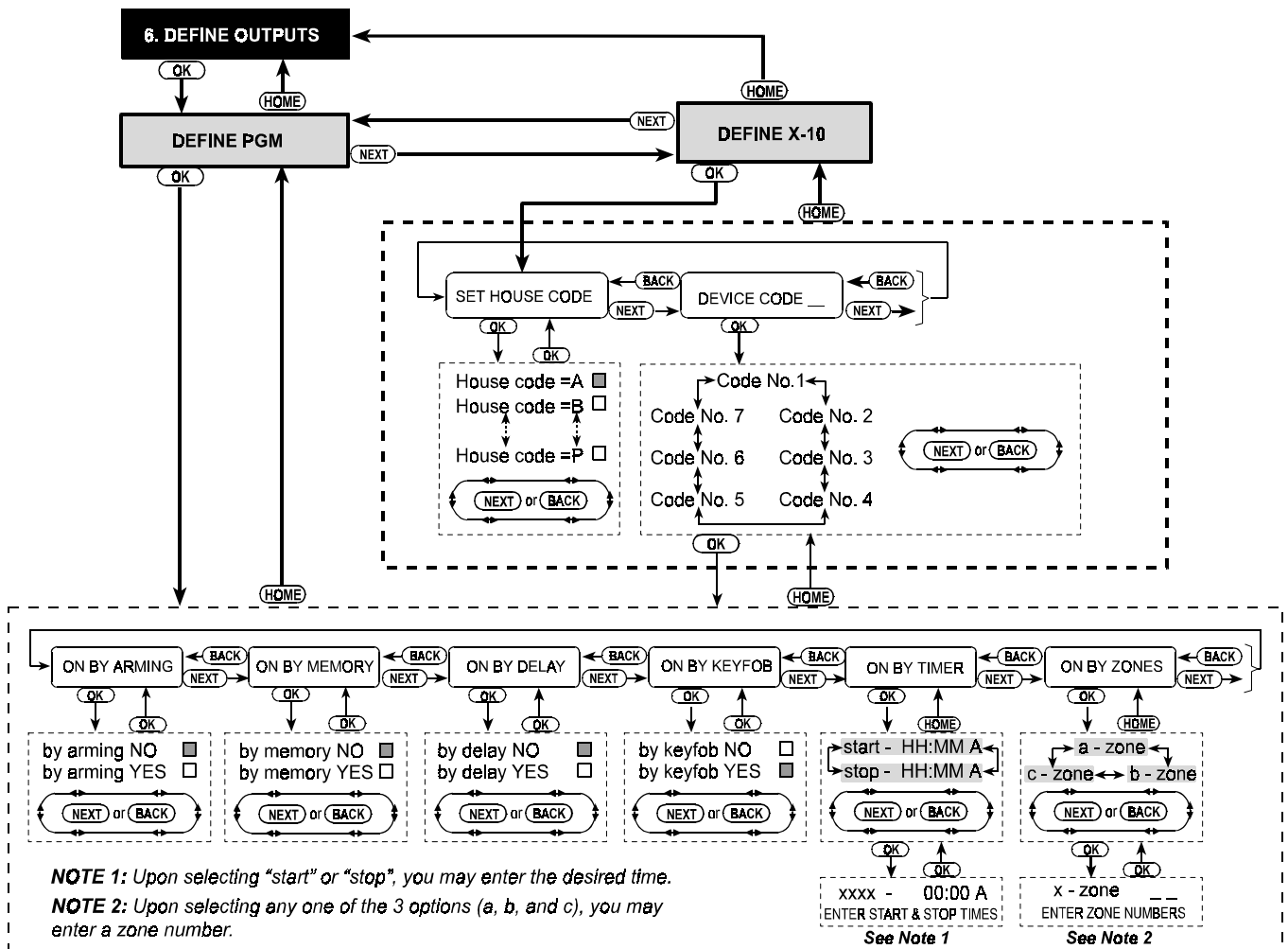

Figure 6. DEFINE OUTPUTS Flow Chart

DEFINE PGM

There are two sub-modes: **DEFINE PGM** and **DEFINE X-10**. You can toggle between them by clicking **<NEXT>**.

C. Programming Multiple-Choice Locations

If a multiple choice location is selected, its name will be displayed as shown in this example:

SET HOUSE CODE

A few options are available, but once you click **<OK>**, the currently saved option will be displayed with a **dark selection box** at the far right:

house code = A

If you approve of this option, click **<OK>**. The “Happy Tune” will sound (- - - —) and the display will revert to its previous state (“**SET HOUSE CODE**” in this case).

If you do not approve, review the other options by clicking **<NEXT>** repeatedly. Options that are not saved will have a clear space at the far right, as shown:

house code = B

To select an option that is not currently saved, click **<OK>**. A dark box will appear at the far right. Clicking **<OK>** once more will cause your selection to be saved - the “Happy tune” will sound and the display will revert to its previous state (“**SET HOUSE CODE**” in this case).

D. Programming Numerical Data Locations

In case of a numerical data location, refer to the detailed procedure given in the following paragraphs.

7.2 PGM Output Control

Here you determine which factors will activate the PGM output. The available options are:

■ **on by arming**: activated upon arming and deactivated upon disarming.

■ **on by memory**: activated upon registration of an alarm in the system’s memory and deactivated when the memory indication is cleared.

■ **on by delay**: activated during the exit and entry delays.

■ **on by keyfob**: activated by pressing the AUX (fourth) button of a keyfob transmitter - provided that “**PGM/X-10**” is selected in location 16 of the “Define Panel” menu. The duration of activation depends on the option selected in location 19 of the “Define Panel” menu.

■ **on by timer**: activated and deactivated at specific preset times.

■ **on by zones**: activated by disturbance in 3 selected zones, irrespective of arming / disarming. The duration of activation depends on the option selected in location 19 of the “Define Panel” menu.

Note: The PGM output may be programmed for activation by any combination of factors.

A. Upon clicking **<OK>** while “**6. DEFINE OUTPUTS**” is shown, the display will change to:

DEFINE PGM

B. Click **<OK>**. The display will change into:

ON BY ARMING

C. Select the desired option (YES or NO) as outlined in Para. 7.1 C above. When done, click **<NEXT>** to select the next item on the menu.

D. Go through the next 3 menu items (ON BY MEMORY, ON BY DELAY and ON BY KEFOB), selecting the desired option for each. After that, clicking **<NEXT>** will change the display into:

ON BY TIMER

E. Click **<OK>**. The display will read:

start - HH:MM A

F. Click **<OK>**. The display will change to:

start - 00:00 A

G. Enter the time at which you wish the output to be activated.

Note: AM and PM are selected by clicking “#” and “*”, respectively.

Once the time on display is correct, regardless of the cursor position, click **<OK>** twice. The happy tune will sound and the display will revert to: “**start - HH:MM**”

H. Click **<NEXT>**. The display will now read:

stop - HH:MM P

I. Click **<OK>**. The display will change to:

stop - 00:00 P

J. Enter the time at which you wish the output to be deactivated. Once the time on display is correct, regardless of the cursor position, click **<OK>** twice. The happy tune will sound and the display will revert to “**stop - HH:MM**”

K. Click **<HOME>** to return to “**ON BY TIMER**” and then **<NEXT>**. The display will show:

ON BY ZONES

L. Click **<OK>**. The display will read:

a - zone

M. Click **<OK>**. The display will change to:

a - zone --

N. Enter the number of the first zone that you designate for activating this output, and then click **<OK>**. The display will revert to “**a - zone**”.

O. Click **<NEXT>** to select “**b - zone**” and repeat steps L through N for the second zone. When done, the display will revert to “**b - zone**”.

P. Click **<NEXT>** to select “**c - zone**” and repeat steps L through N for the third zone. When done, the display will revert to “**C - zone**”.

Q. Click **<HOME>** to return to “**ON BY ZONES**” and then **<HOME>** again. The display will show:

DEFINE PGM

R. Click **<NEXT>** to select the “**DEFINE X-10**” sub-mode and then continue as in 7.3 below.

7.3 Controlling the X-10 Units

Here you can perform the following programming actions:

- Select the house code (a code letter from A to P that will distinguish the site in which the system is installed from other sites in the neighborhood).
- Select the factors that will activate each X-10 unit. The list of factors is the same as for the PGM output (see Para. 7.2 above).

Note: Each X-10 unit may be programmed for activation by any combination of factors.

Having gained access to **DEFINE X-10** (see Para. 7.1 B), proceed as follows:

- A. Click **<OK>** while **DEFINE X-10** is displayed. The display will show:

SET HOUSE CODE

- B. Click **<OK>** again. The display will read:

house code = X ■

The "X" represents a letter from A to P and the dark box means that this letter is the current choice.

- C. Click **<NEXT>** or **<BACK>** repeatedly to reach the desired code letter. When it is on display, click **<OK>** twice. The display will revert to **Set House Code**. Then click **<NEXT>**. The display will change to:

DEVICE CODE

The system controls up to seven X-10 units. If you click **<OK>** now, code No. 1 will be selected automatically:

code no. 1

- D. Click **<NEXT>** or **<BACK>** to select any other code.

Once the desired code is displayed, click **<OK>**. The display will change to:

ON BY ARMING

- E. Continue as in Paragraph 7.2, Steps C through P, until you finish defining the factors that will activate the selected X-10 unit. When done, Click **<HOME>** to select any other X-10 unit and program the factors that will activate it the same way as you did for the first one.
- F. Once you are through dealing with all 7 (or just all relevant) device codes, you have completed a full cycle of the **DEFINE OUTPUTS** mode.



If at this point you wish to return to the installer's menu, click **<AWAY>**. This will get you back to:

<OK> TO EXIT

You may now review and select any other mode on the installer's menu (by clicking **<NEXT>** or **<BACK>**).

8. RECORDING SPEECH

8.1 Mode Description and Activation

This mode allows you to record short-duration speech messages for two purposes:

- **House identity** is a message announced automatically when events are reported to private telephones.
- **3 custom zone names** can be recorded and assigned to specific zones. These names prove useful if none of the 26 fixed zone names are found suitable for a certain zone (see Para. 4.2, Step G.).

To activate the recording mode, proceed as follows:

- A. Upon gaining access to the installer menu (see Section 1), the display will read "1. NEW INSTL CODE".

- B. Click **<NEXT>** until the 7th mode is displayed:

7. RECORD SPEECH

8.2 Recording Procedure

Having gained access to the **RECORD SPEECH** mode, you can now record the house identity.

- A. Click **<OK>**. The display will change into:

HOUSE IDENTITY

- B. Press the **<2>** key until this is displayed briefly:

RECORD A MESSAGE

Immediately thereafter, the display will change into:

TALK NOW ■■■■

- C. Do not release the **<2>** key and start talking immediately, while facing the front panel. The dark square boxes will slowly disappear one by one, from right to left. When the last one disappears (10 seconds later) the following message will be displayed:

RECORDING ENDED

- D. Release the **<2>** key. To check the message, press the **<5>** key and listen to the playback.

- E. Click **<NEXT>**. The display will change into:

USER TERM #1

- F. Record the first customized zone name using the same procedure as in Steps B through D above.

- G. Click **<NEXT>** and repeat the procedure for the **2nd zone name** and **3rd zone name**. When done, click **<HOME>** to return to the main menu.

You may now click **<NEXT>** to test the system (see Section 9).

9. DIAGNOSTIC TEST

9.1 Mode Description and Activation

This mode allows you to test the function of all wireless sensors deployed throughout the protected area, to collect information about the received signal strength from each transmitter and to review accumulated data after the test.

The diagnostic test is designed to sense and report 3 reception levels as shown in the following table:

Reception	Buzzer Response
Strong	Happy Tune twice (- - - —) (- - - —)
Good	Happy Tune (- - - —)
Poor	Sad tune (—————)

To activate the diagnostic mode, proceed as follows:

- A. Upon gaining access to the installer menu (see Section 1), the display will read "1. NEW INSTL CODE".

- B. Click **<NEXT>** until the 8th mode is displayed:

8. DIAGNOSTICS

You may now conduct a walk test to check the system and gather diagnostic data.

***Note:** you may draw conclusions on the level of reception by just listening to the buzzer response. If you are not sure though, you may review the test results upon conclusion of the test (see Para. 9.2, Step C).*

9.2 Test Procedure

Having gained access to the DIAGNOSTICS mode, proceed as follows:

A. Click <OK>. The display will read:

DIAG. TESTING

B. Walk test the entire protected site, making sure that all detectors and sensors are triggered into alarm. Whenever a sensor alarms, the zone name, number and reception level will be displayed - see this example:

Bathroom



Z19 STRONG



DIAG. TESTING

You may listen to the buzzer response to signals received from each sensor, thus being informed of the signal level (see table in Para. 9.1). If the buzzer does not respond - the signal was not received.

C. Upon completion of the test, you may review the results by pressing <OK> repeatedly. The test results appear one by one, starting with zone 1 and going up.

FRONT DOOR

(alternating for 5 seconds)

Z1 POOR

and then:

LIVING ROOM

(alternating for 5 seconds)

Z2 GOOD

D. To focus the test on a specific zone, click <OK> until the reception level for that zone is displayed. Then resume testing this particular zone (re-locate the wireless sensor or remove objects that might block its transmission) until you are satisfied with the results.

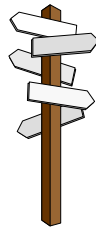

If at any time you wish to return to the installer's menu, click <AWAY>. This will get you back to:

<OK> TO EXIT

You may now review and select any other mode on the installer's menu (by clicking <NEXT> or <BACK>).

10. USER FUNCTIONS

This mode provides you with a gateway to the user functions through the regular user programming menu. You may:

- Program the 4th (follow-me) telephone number
- Program user codes
- Select the voice option
- Set the system clock
- Set the Date

Refer to the User Guide for detailed procedures.

Caution! If after having programmed the user codes the system does not recognize your installer code, you must have programmed a user code that is identical with your installer code. If so, access the user menu and change the code which is identical with your installer code. This will re-validate your installer code.

11. READING THE EVENT LOG

11.1 Event Log Description

All events are memorized in an event log that contains up to 100 entries. You can access this log, review the events one by one and draw technical and functional conclusions.

If the event log fills up completely (the number of registered events reaches 100) it continues to accept new events at the expense of old events - the oldest event is deleted upon registration of each new event.

The date and time of occurrence are memorized for each event. When reading the event log, events are shown in chronological order - from the newest to the oldest.

Because of the limited display space, the event description is shown first, then the date and time. The two displays are shown alternately several times, until you click <OK> to move on to an older event, or until the "no action" 4-minute timeout restores the system to the normal operating mode.

Access to the event log is provided by clicking the asterisk (*) key and not through the regular installer's menu.

Should you wish to get an overall view of using the log, refer to Figure 7. The chart there may even serve as your only guide to using the event log, instead of going through the written step-by-step procedure.

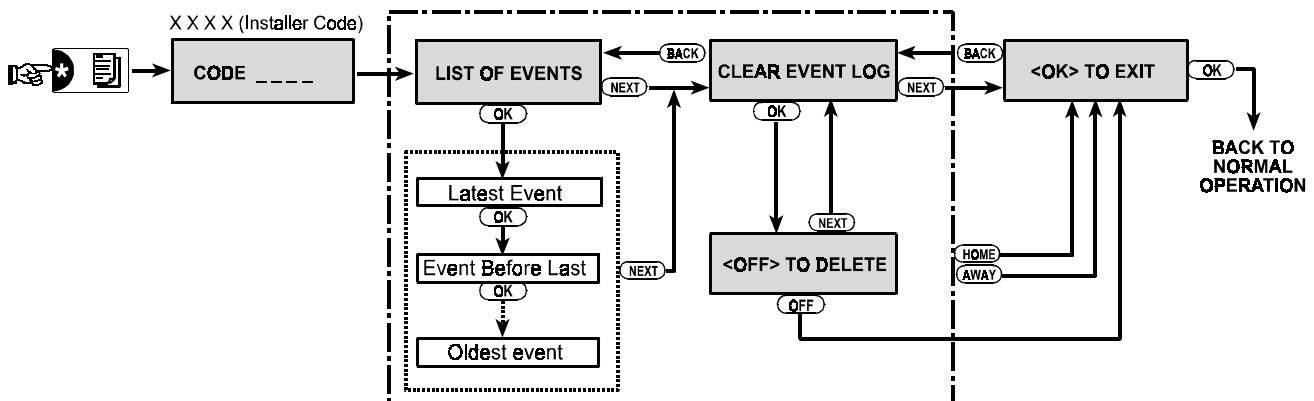

Figure 7. Using the Event Log

11.2 Reading Procedure

To read the event log, proceed as follows:

- A. While the system is in the normal operating mode, click the asterisk (**★**) key. The display will change to:

CODE _ _ _ _

- B. Enter the current installer code. If the code is correct, the “Happy Tune” will sound and the display will read:

LIST OF EVENTS

Important! Entering an incorrect code 3 times in a row will initiate a 30-second penalty lockout of the keypad.

- C. Click **<OK>**. The latest event will be shown. Suppose that the latest event was an alarm in zone 13. The display will now read:

Z 13 ALARM

and then:

09 / 02 / 99 3 : 37 P

The two displays will be shown alternately until you click **<OK>** again to move to the next event, or until the event log times out (4 minutes).

- D. Click **<OK>** as many times as necessary to read all the data you need.

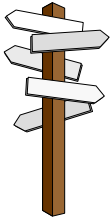

- To clear the event log, refer to Para. 11.3.
- To quit the event log:
 - Click **<HOME>** or **<AWAY>** from anywhere within the log. The display will read:
<OK> TO EXIT
 - Click **<OK>**. The system will return to the normal operating mode.

11.3 Erasing the Event Log

- A. From anywhere within the event log, click **<NEXT>**. The display will change to:

CLEAR EVENT LOG

- B. Click **<OK>**. The display will change to:

<OFF> TO DELETE

- C. Click **<OFF>**. The “Happy Tune” will sound and the display will change to:

<OK> TO EXIT

Note: If you change your mind before clicking **<OFF>**, click **<HOME>** or **<AWAY>**. This will also get you to “**<OK> TO EXIT**” without erasing the event log. Clicking **<NEXT>** will return you to “**CLEAR EVENT LOG**”.

- D. Click **<OK>**. The system will revert to the normal operating mode.

APPENDIX A. EVENT CODES

Contact ID Event Codes

Code	Definition
101	Emergency
110	Fire
120	Panic
121	Duress
122	Silent
123	Audible
131	Perimeter
132	Interior
134	Entry/Exit
137	Tamper/CP
301	AC loss
302	Low system battery
321	Bell
344	RF receiver jam detect
350	Communication trouble
351	Telco fault
381	Loss of supervision RF
383	Sensor tamper
384	RF low battery
401	O/C by user
406	Cancel
408	Quick arm
441	Armed home
456	Partial arm
459	Recent close
602	Periodic test report
607	Walk test mode
641	Senior watch trouble

SIA Event Codes

Code	Definition
AR	AC Restore
AT	AC Trouble
BA	Burglary Alarm
BC	Burglary Cancel
BR	Burglary Restore
BT	Burglary Trouble / Jamming
BZ	Missing Supervision
CF	Forced Closing
CL	Closing Report
FA	Fire Alarm
FR	Fire Restore
HA	Holdup Alarm (duress)
LR	Phone Line Restore
LT	Phone Line Trouble
OP	Opening Report
PA	Panic Alarm
QA	Emergency Alarm
RP	Automatic Test
RX	Manual Test
RY	Exit from Manual Test
TA	Tamper Alarm
TR	Tamper Restore
XR	Sensor Battery Restore
XT	Sensor Battery Trouble
YR	System Battery Restore
YT	System Battery Trouble
YX	Service Required

4/2 Event Codes

Alarms

Zone No. →	1	2	3	4	5	6	7	8	9	10	11	12	13	14	15
1 st digit	4	4	4	4	4	4	4	4	4	4	4	4	4	4	4
2 nd digit	1	2	3	4	5	6	7	8	9	A	B	C	D	E	F

Zone No. →	16	17	18	19	20	21	22	23	24	25	26	27	28	29	30
1 st digit	5	5	5	5	5	5	5	5	5	5	5	5	5	5	5
2 nd digit	1	2	3	4	5	6	7	8	9	A	B	C	D	E	F

Restorals

Zone No. →	1	2	3	4	5	6	7	8	9	10	11	12	13	14	15
1 st digit	C	C	C	C	C	C	C	C	C	C	C	C	C	C	C
2 nd digit	1	2	3	4	5	6	7	8	9	A	B	C	D	E	F

Zone No. →	16	17	18	19	20	21	22	23	24	25	26	27	28	29	30
1 st digit	D	D	D	D	D	D	D	D	D	D	D	D	D	D	D
2 nd digit	1	2	3	4	5	6	7	8	9	A	B	C	D	E	F

Supervisory trouble

Zone No. →	1	2	3	4	5	6	7	8	9	10	11	12	13	14	15
1 st digit	6	6	6	6	6	6	6	6	6	6	6	6	6	6	6
2 nd digit	1	2	3	4	5	6	7	8	9	A	B	C	D	E	F

Zone No. →	16	17	18	19	20	21	22	23	24	25	26	27	28	29
1 st digit	7	7	7	7	7	7	7	7	7	7	7	7	7	7
2 nd digit	1	2	3	4	5	6	7	8	9	A	B	C	D	E

Low Battery

Zone No. →	1	2	3	4	5	6	7	8	9	10	11	12	13	14	15
1 st digit	8	8	8	8	8	8	8	8	8	8	8	8	8	8	8
2 nd digit	1	2	3	4	5	6	7	8	9	A	B	C	D	E	F

Zone No. →	16	17	18	19	20	21	22	23	24	25	26	27	28	29
1 st digit	9	9	9	9	9	9	9	9	9	9	9	9	9	9
2 nd digit	1	2	3	4	5	6	7	8	9	A	B	C	D	E

Forced Arming – 8 users

User No. →	1	2	3	4	5	6	7	8
1 st digit	A	A	A	A	A	A	A	A
2 nd digit	1	2	3	4	5	6	7	8

Panic / 24 Hours - 8 users

User No. →	1	2	3	4	5	6	7	8	Panic CP
1 st digit	2	2	2	2	2	2	2	2	2
2 nd digit	1	2	3	4	5	6	7	8	9

Note: Panic and Duress share the same code.

Arm HOME and AWAY (Closing)

User No. →	1	2	3	4	5	6	7	8	Cancel alarm	Recent Close
1 st digit	E	E	E	E	E	E	E	E	E	E
2 nd digit	1	2	3	4	5	6	7	8	9	C

Disarm (Opening)

User No. →	1	2	3	4	5	6	7	8
1 st digit	F	F	F	F	F	F	F	F
2 nd digit	1	2	3	4	5	6	7	8

Trouble

Event →	Fuse Fail	Fuse Restore	Jamming	Jamming Restore
1 st digit	2	2	2	2
2 nd digit	C	D	E	F

Event →	AC Failure	AC Restore	CPU Low Battery	CPU Low Battery Restore	CP tamper	CP tamper restore	No Active
1 st digit	1	1	1	1	1	1	1
2 nd digit	1	2	3	4	6	7	8

Event →	COMM. & LINE Restore	Enter Test	Exit Test	Auto Test
1 st digit	1	1	1	1
2 nd digit	A	D	E	F

NOTES:

A series of horizontal dotted lines for taking notes.

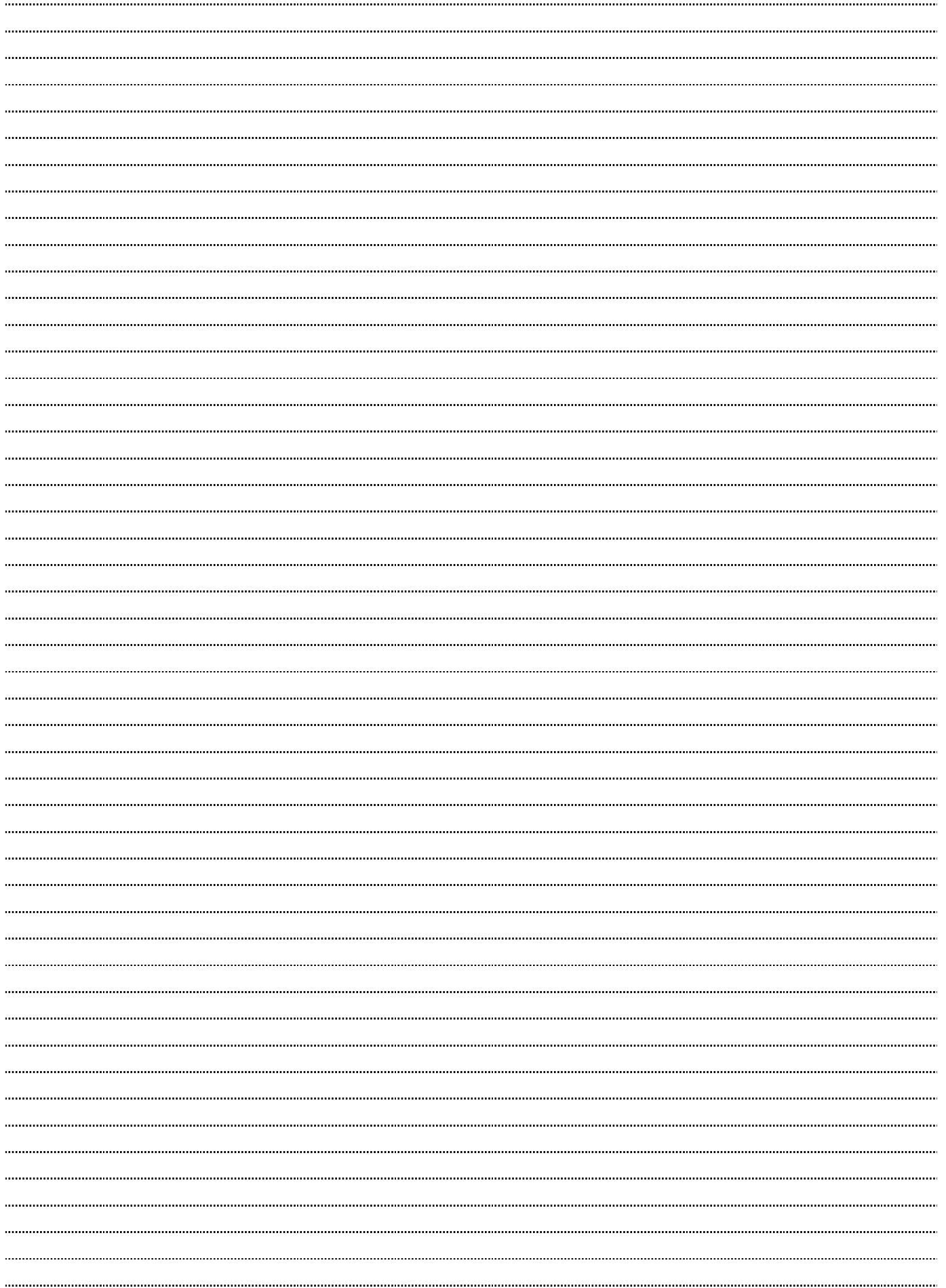



VISONIC LTD. (ISRAEL): P.O.B 22020 TEL-AVIV 61220 ISRAEL. PHONE: (972-3) 645-6789, FAX: (972-3) 645-6788

VISONIC INC. (U.S.A.): 10 NORTHWOOD DRIVE, BLOOMFIELD CT. 06002-1911. PHONE: (860) 243-0833, (800) 223-0020. FAX: (860) 242-8094

VISONIC LTD. (UK): UNIT 1, STRATTON PARK, DUNTON LANE, BIGGLESWADE, BEDS. SG18 8QS. PHONE: (01767) 600857 FAX: (01767) 601098

INTERNET: www.visonic.com

©VISONIC LTD. 2000 POWERMAX DE5450P (REV. 2, 8/00)

